

FEATURES

- Allows safe board insertion and removal from a live backplane
- Controls supply voltages from 3.15 V to 16.5 V
- Precision current sense amplifier
- Precision voltage input
- 12-bit ADC for current and voltage readback
- Charge pumped gate drive for external N-channel FET
- Adjustable analog current limit with circuit breaker
- ±3% accurate hot swap current limit level
- Fast response limits peak fault current
- Automatic retry or latch-off on current fault
- Programmable hot swap timing via TIMER pin
- Active high and active low ON/ONB pin options
- Convert start pin (CONV)
- I²C fast mode-compliant interface (400 kHz maximum)
- 10-lead MSOP

APPLICATIONS

- Power monitoring/power budgeting
- Central office equipment
- Telecommunications and data communications equipment
- PCs/servers

GENERAL DESCRIPTION

The ADM1175 is an integrated hot swap controller and current sense amplifier that offers digital current and voltage monitoring via an on-chip, 12-bit analog-to-digital converter (ADC), communicated through an I²C® interface.

An internal current sense amplifier measures voltage across the sense resistor in the power path via the VCC pin and the SENSE pin.

The ADM1175 limits the current through this resistor by controlling the gate voltage (via the GATE pin) of an external N-channel FET in the power path. The voltage across the sense resistor (and, therefore, the inrush current) is kept below a preset maximum.

The ADM1175 protects the external FET by limiting the time that the maximum current runs through it. This current limit period is set by the value of the capacitor attached to the TIMER pin. Additionally, the device provides protection from overcurrent events that may occur once the hot swap event is complete. In the case of a short-circuit event, the current in the sense resistor exceeds an overcurrent trip threshold, and the FET is switched off immediately by pulling down the GATE pin.

FUNCTIONAL BLOCK DIAGRAM

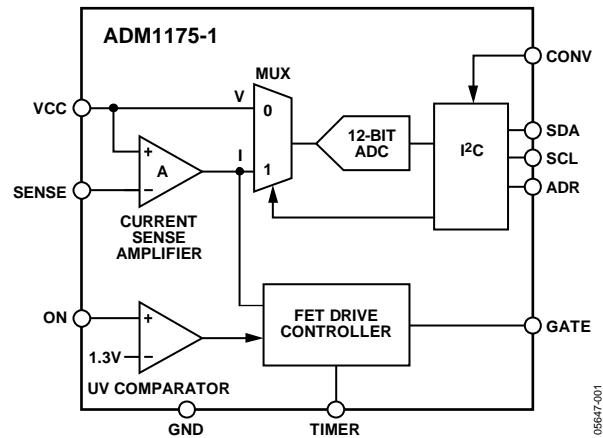

Figure 1.

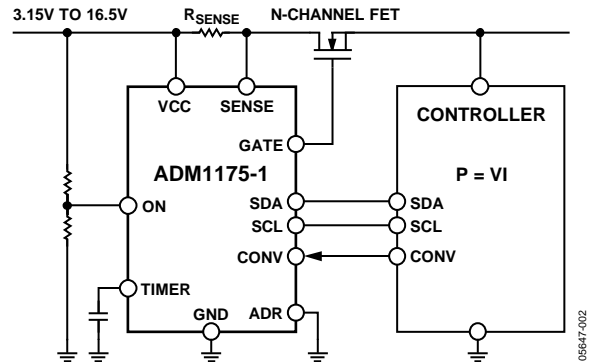

Figure 2. Applications Diagram

A 12-bit ADC can measure the current seen in the sense resistor, as well as the supply voltage on the VCC pin. An industry-standard I²C interface allows a controller to read current and voltage data from the ADC. Measurements can be initiated by an I²C command or via the convert (CONV) pin. The CONV pin is especially useful for synchronizing reads on multiple ADM1175 devices. Alternatively, the ADC can run continuously, and the user can read the latest conversion data whenever it is required. Up to four unique I²C addresses can be created, depending on how the ADR pin is connected.

The ADM1175 is packaged in a 10-lead MSOP.

Rev. B

Information furnished by Analog Devices is believed to be accurate and reliable. However, no responsibility is assumed by Analog Devices for its use, nor for any infringements of patents or other rights of third parties that may result from its use. Specifications subject to change without notice. No license is granted by implication or otherwise under any patent or patent rights of Analog Devices. Trademarks and registered trademarks are the property of their respective owners.

TABLE OF CONTENTS

Features	1	Initial Timing Cycle	13
Applications.....	1	Hot Swap Retry Cycle on the ADM1175-1 and the ADM1175-3	14
General Description	1	Voltage and Current Readback.....	15
Functional Block Diagram	1	Serial Bus Interface.....	15
Revision History	2	Identifying the ADM1175 on the I ² C Bus.....	15
Specifications.....	3	General I ² C Timing.....	15
Absolute Maximum Ratings.....	5	Write and Read Operations.....	17
Thermal Characteristics	5	Quick Command.....	17
ESD Caution.....	5	Write Command Byte	17
Pin Configuration and Function Descriptions.....	6	Write Extended Command Byte	18
Typical Performance Characteristics	7	Read Voltage and/or Current Data Bytes.....	19
Overview of the Hot Swap Function.....	12	Applications Information	21
Undervoltage Lockout	12	Applications Waveforms.....	21
ON/ONB Function.....	12	Kelvin Sense Resistor Connection	22
TIMER Function	12	Outline Dimensions	23
GATE and TIMER Functions During a Hot Swap Operation.....	13	Ordering Guide	23
Calculating Current Limits and Fault Current Limit Time..	13		

REVISION HISTORY

2/08—Rev. A to Rev. B

Changed V _{VCC} to V _{CC} Throughout	3
Changes to Input Current for 00 Decode, I _{ADRLOW} Parameter.....	3
Changes to Input Current for 11 Decode, I _{ADRHIGH} Parameter.....	3
Added ADC Conversion Time Parameter	4
Added Fast Overcurrent Response Time Parameter	4
Added Endnote 2 and Endnote 3	4
Changes to Figure 14.....	8
Changes to Figure 15 Caption.....	8
Changes to Figure 24.....	10
Changes to TIMER Function Section	12
Changes to Table 5.....	15
Changes to General I ² C Timing Section.....	15
Changes to Quick Command Section	17
Changes to Figure 35.....	17
Changes to Table 7.....	17
Changes to Write Extended Command Byte Section.....	18
Changes to Figure 37.....	18
Changes to Table 9 and Table 11.....	18
Changes to Converting ADC Codes to Voltage and Current Readings Section.....	19

4/07—Rev. 0 to Rev. A

Changes to Table 4.....	7
Changes to GATE and TIMER Functions During a Hot Swap Section.....	14
Changes to Calculating Current Limits and Fault Current Limit Time Section.....	14
Changes to Initial Timing Cycle Section.....	14
Changes to Table 5.....	16
Changes to Figure 32 and Figure 33.....	17
Changes to Figure 37.....	19
Changes to Figure 39 and Figure 40.....	20
Added Applications Information Heading	22

9/06—Revision 0: Initial Version

SPECIFICATIONS

$V_{CC} = 3.15\text{ V to }16.5\text{ V}$; $T_A = -40^\circ\text{C to }+85^\circ\text{C}$; typical values at $T_A = 25^\circ\text{C}$, unless otherwise noted.

Table 1.

Parameter	Min	Typ	Max	Unit	Conditions
VCC PIN					
Operating Voltage Range, V_{CC}	3.15		16.5	V	
Supply Current, I_{CC}		1.7	2.5	mA	
Undervoltage Lockout, V_{UVLO}		2.8		V	V_{CC} rising
Undervoltage Lockout Hysteresis, $V_{UVLOHYST}$		80		mV	
ON/ONB PIN					
Input Current, I_{INON}	-100		+100	nA	ON/ONB < 1.5 V
	-2		+2	μA	
Rising Threshold, V_{ONTH}	1.26	1.3	1.34	V	ON/ONB rising
Trip Threshold Hysteresis, V_{ONHYST}	35	50	65	mV	
Glitch Filter Time		3		μs	
CONV PIN					
Input Current, I_{INCONV}	-1		+1	μA	$V_{CONV(MAX)} = 3.6\text{ V}$
Trip Threshold Low, V_{CONVL}			1.2	V	
Trip Threshold High, V_{CONVH}	1.4			V	
SENSE PIN					
Input Leakage, I_{SENSE}	-1		+1	μA	$V_{SENSE} = V_{CC}$
Overcurrent Fault Timing Threshold, V_{OCTRIM}	92			mV	$V_{OCTRIM} = (V_{CC} - V_{SENSE})$, fault timing starts on the TIMER pin
Overcurrent Limit Threshold, V_{LIM}	97	100	103	mV	$V_{LIM} = (V_{CC} - V_{SENSE})$, closed-loop regulation to a current limit
Fast Overcurrent Trip Threshold, V_{OCFAST}			115	mV	$V_{OCFAST} = (V_{CC} - V_{SENSE})$, gate pull-down current turned on
GATE PIN					
Drive Voltage, V_{GATE}	3	6	9	V	$V_{GATE} - V_{CC}, V_{CC} = 3.15\text{ V}$
	9	11	13	V	$V_{GATE} - V_{CC}, V_{CC} = 5\text{ V}$
	7	10	13	V	$V_{GATE} - V_{CC}, V_{CC} = 16.5\text{ V}$
Pull-Up Current	8	12.5	17	μA	$V_{GATE} = 0\text{ V}$
Pull-Down Current		1.5		mA	$V_{GATE} = 3\text{ V}, V_{CC} = 3.15\text{ V}$
		5		mA	$V_{GATE} = 3\text{ V}, V_{CC} = 5\text{ V}$
		7		mA	$V_{GATE} = 3\text{ V}, V_{CC} = 16.5\text{ V}$
TIMER PIN					
Pull-Up Current (Power-On Reset), $I_{TIMERUPPOR}$	-3.5	-5	-6.5	μA	Initial cycle, $V_{TIMER} = 1\text{ V}$
Pull-Up Current (Fault Mode), $I_{TIMERUPFAULT}$	-40	-60	-80	μA	During current fault, $V_{TIMER} = 1\text{ V}$
Pull-Down Current (Retry Mode), $I_{TIMERDNRETRY}$		2	3	μA	After current fault and during a cooldown period on a retry device, $V_{TIMER} = 1\text{ V}$
Pull-Down Current, $I_{TIMERDN}$		100		μA	Normal operation, $V_{TIMER} = 1\text{ V}$
Trip Threshold High, V_{TIMERH}	1.26	1.3	1.34	V	TIMER rising
Trip Threshold Low, V_{TIMERL}	0.175	0.2	0.225	V	TIMER falling
ADR PIN					
Set Address to 00, V_{ADRL0V}	0		0.8	V	Low state
Set Address to 01, R_{ADRL0V}	135	150	165	k Ω	Resistor to ground state, load pin with specified resistance for 01 decode
Set Address to 10, $I_{ADRHIGHZ}$	-1		+1	μA	Open state, maximum load allowed on the ADR pin for 10 decode
Set Address to 11, $V_{ADRHIGHV}$	2		5.5	V	High state
Input Current for 00 Decode, I_{ADRLOW}	-40	-22		μA	$V_{ADR} = 0\text{ V to }0.8\text{ V}$
Input Current for 11 Decode, $I_{ADRHIGH}$		3	10	μA	$V_{ADR} = 2.0\text{ V to }5.5\text{ V}$

ADM1175

Parameter	Min	Typ	Max	Unit	Conditions
MONITORING ACCURACY¹					
Current Sense Absolute Accuracy					
0°C to +70°C	-1.45		+1.45	%	V _{SENSE} = 75 mV
	-1.8		+1.8	%	V _{SENSE} = 50 mV
	-2.8		+2.8	%	V _{SENSE} = 25 mV
	-5.7		+5.7	%	V _{SENSE} = 12.5 mV
0°C to +85°C	-1.5		+1.5	%	V _{SENSE} = 75 mV
	-1.8		+1.8	%	V _{SENSE} = 50 mV
	-2.95		+2.95	%	V _{SENSE} = 25 mV
	-6.1		+6.1	%	V _{SENSE} = 12.5 mV
-40°C to +85°C	-1.95		+1.95	%	V _{SENSE} = 75 mV
	-2.45		+2.45	%	V _{SENSE} = 50 mV
	-3.85		+3.85	%	V _{SENSE} = 25 mV
	-6.7		+6.7	%	V _{SENSE} = 12.5 mV
V _{SENSE} for ADC Full Scale ²		105.84		mV	
Voltage Sense Accuracy					
0°C to +70°C	-0.85		+0.85	%	V _{CC} = 3 V minimum (low range)
	-0.9		+0.9	%	V _{CC} = 6 V minimum (high range)
0°C to +85°C	-0.85		+0.85	%	V _{CC} = 3 V minimum (low range)
	-0.9		+0.9	%	V _{CC} = 6 V minimum (high range)
-40°C to +85°C	-0.9		+0.9	%	V _{CC} = 3 V minimum (low range)
	-1.15		+1.15	%	V _{CC} = 6 V minimum (high range)
V _{CC} for ADC Full Scale ³					
Low Range (VRANGE = 1)		6.65		V	
High Range (VRANGE = 0)		26.35		V	
I²C TIMING					
Low Level Input Voltage, V _{IL}			0.3 V _{BUS}	V	
High Level Input Voltage, V _{IH}	0.7 V _{BUS}			V	
Low Level Output Voltage on SDA, V _{OL}			0.4	V	I _{OL} = 3 mA
Output Fall Time on SDA from V _{IHMIN} to V _{ILMAX}	20 + 0.1 C _{BUS}		250	ns	C _{BUS} = bus capacitance from SDA to GND
Maximum Width of Spikes Suppressed by Input Filtering on SDA and SCL Pins	50		250	ns	
Input Current, I _I , on SDA/SCL When Not Driving a Logic Low Output	-10		+10	μA	
Input Capacitance on SDA/SCL		5		pF	
SCL Clock Frequency, f _{SCL}			400	kHz	
Low Period of the SCL Clock	600			ns	
High Period of the SCL Clock	1300			ns	
ADC Conversion Time ⁴		150		μs	
Fast Overcurrent Response Time ⁵		4	10	μs	
Setup Time for a Repeated Start Condition, t _{SU,STA}	600			ns	
SDA Output Data Hold Time, t _{HD,DAT}	100		900	ns	
Setup Time for a Stop Condition, t _{SU,STO}	600			ns	
Bus Free Time Between a Stop and a Start Condition, t _{BUF}	1300			ns	
Capacitive Load for Each Bus Line			400	pF	

¹ Monitoring accuracy is a measure of the error in a code that is read back for a particular voltage/current. This is a combination of amplifier error, reference error, ADC error, and error in ADC full-scale code conversion factor.

² This is an absolute value to be used when converting ADC codes to current readings; any inaccuracy in this value is factored into absolute current accuracy values (see specifications for Current Sense Absolute Accuracy).

³ These are absolute values to be used when converting ADC codes to voltage readings; any inaccuracy in these values is factored into voltage accuracy values (see specifications for Voltage Sense Accuracy).

⁴ Time between the receipt of the command byte and the actual ADC result being placed in the register.

⁵ Guaranteed by design; not production tested.

ABSOLUTE MAXIMUM RATINGS

Table 2.

Parameter	Rating
VCC Pin	20 V
SENSE Pin	20 V
TIMER Pin	-0.3 V to +6 V
ON/ONB Pin	-0.3 V to +20 V
CONV Pin	-0.3 V to +6 V
GATE Pin	30 V
SDA Pin, SCL Pin	-0.3 V to +7 V
ADR Pin	-0.3 V to +6 V
Storage Temperature Range	-65°C to +125°C
Operating Temperature Range	-40°C to +85°C
Lead Temperature (Soldering, 10 sec)	300°C
Junction Temperature	150°C

Stresses above those listed under Absolute Maximum Ratings may cause permanent damage to the device. This is a stress rating only; functional operation of the device at these or any other conditions above those indicated in the operational section of this specification is not implied. Exposure to absolute maximum rating conditions for extended periods may affect device reliability.

THERMAL CHARACTERISTICS

θ_{JA} is specified for the worst-case conditions, that is, a device soldered in a circuit board for surface-mount packages.

Table 3. Thermal Resistance

Package Type	θ_{JA}	Unit
10-Lead MSOP	137.5	°C/W

ESD CAUTION



ESD (electrostatic discharge) sensitive device. Charged devices and circuit boards can discharge without detection. Although this product features patented or proprietary protection circuitry, damage may occur on devices subjected to high energy ESD. Therefore, proper ESD precautions should be taken to avoid performance degradation or loss of functionality.

PIN CONFIGURATION AND FUNCTION DESCRIPTIONS

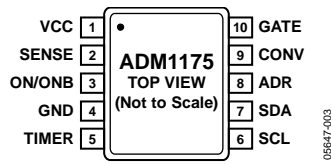

Figure 3. Pin Configuration

Table 4. Pin Function Descriptions

Pin No.	Mnemonic	Description
1	VCC	Positive Supply Input Pin. The operating supply voltage range is from 3.15 V to 16.5 V. An undervoltage lockout (UVLO) circuit resets the ADM1175 when a low supply voltage is detected.
2	SENSE	Current Sense Input Pin. A sense resistor between the VCC pin and the SENSE pin sets the analog current limit. The hot swap operation of the ADM1175 controls the external FET gate to maintain the $(V_{CC} - V_{SENSE})$ voltage at or below 100 mV.
3	ON/ONB	Undervoltage or Overvoltage Input Pin. This pin is active high on the ADM1175-1 and ADM1175-2 and active low on the ADM1175-3 and ADM1175-4. An internal undervoltage comparator has a trip threshold of 1.3 V, and the output of this comparator is used as an enable for the hot swap operation. For the ON pin variants with an external resistor divider from VCC to GND, this pin can be used to enable the hot swap operation for a specific voltage on VCC, providing an undervoltage function. Similarly, for the ONB pin variants, an external resistor divider can be used to create an overvoltage function, where the divider sets a voltage on VCC, at which the hot swap operation is switched off, pulling the GATE to ground.
4	GND	Chip Ground Pin.
5	TIMER	Timer Pin. An external capacitor, C_{TIMER} , sets a 270 ms/ μ F initial timing cycle delay and a 21.7 ms/ μ F fault delay. The GATE pin turns off when the TIMER pin is pulled beyond the upper threshold. An overvoltage detection with an external Zener can be used to force this pin high.
6	SCL	I ² C Clock Pin. Open-drain input requires an external resistive pull-up.
7	SDA	I ² C Data I/O Pin. Open-drain input/output. Requires an external resistive pull-up.
8	ADR	I ² C Address Pin. This pin can be tied low, tied high, left floating, or tied low through a resistor to set four different I ² C addresses.
9	CONV	Convert Start Pin. A high level on this pin enables an ADC conversion. The state of an internal control register, which is set through the I ² C interface, configures the part to convert current only, voltage only, or both channels when the convert pin is asserted. This pin must be pulled high to allow conversions to take place.
10	GATE	GATE Output Pin. This pin is the high-side gate drive of an external N-channel FET. This pin is driven by the FET drive controller, which utilizes a charge pump to provide a 12.5 μ A pull-up current to charge the FET GATE pin. The FET drive controller regulates to a maximum load current (100 mV through the sense resistor) by modulating the GATE pin.

TYPICAL PERFORMANCE CHARACTERISTICS

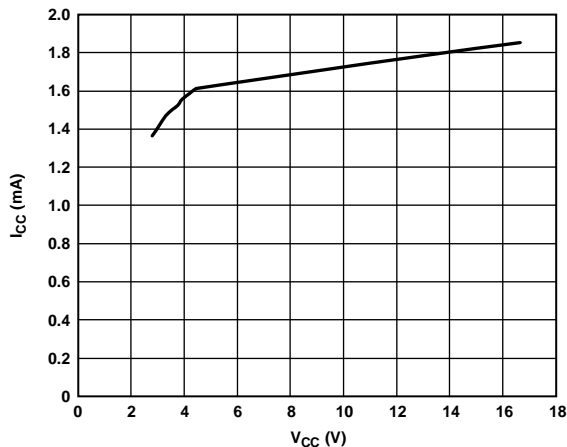

Figure 4. Supply Current vs. Supply Voltage

05647-021

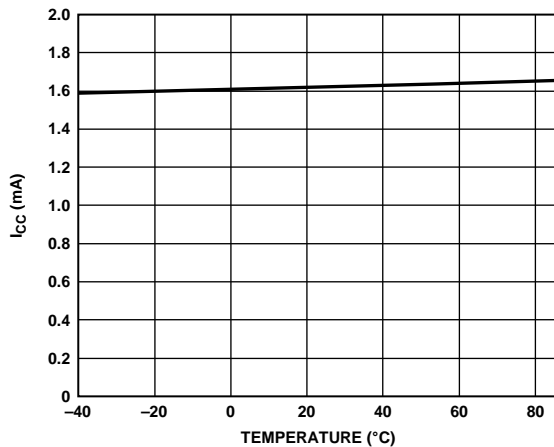

Figure 7. Supply Current vs. Temperature (Gate On)

05647-022

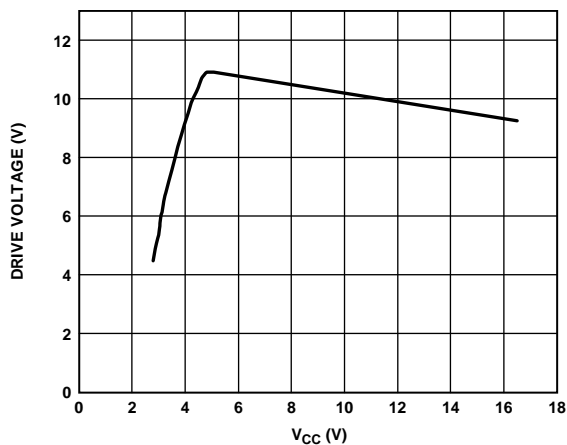

Figure 5. Drive Voltage ($V_{GATE} - V_{CC}$) vs. Supply Voltage

05647-023

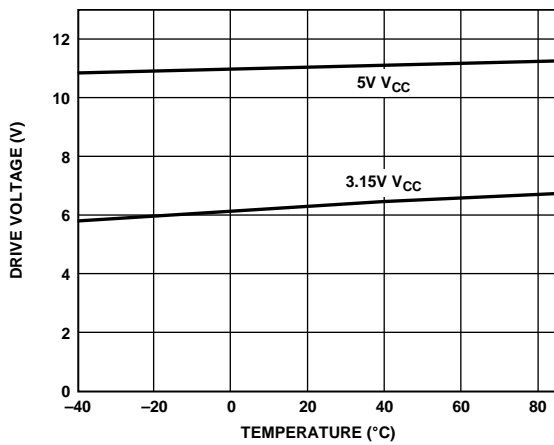

Figure 8. Drive Voltage ($V_{GATE} - V_{CC}$) vs. Temperature

05647-030

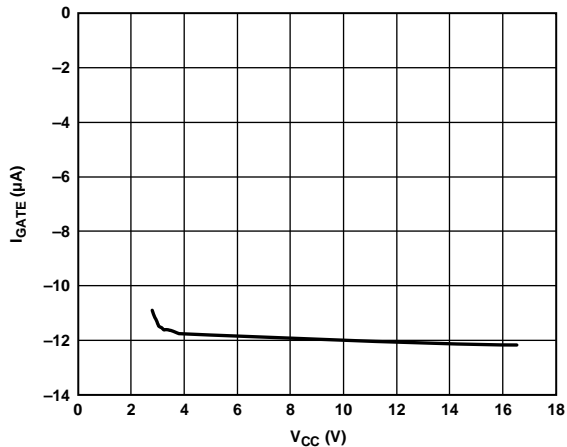

Figure 6. Gate Pull-Up Current vs. Supply Voltage

05647-027

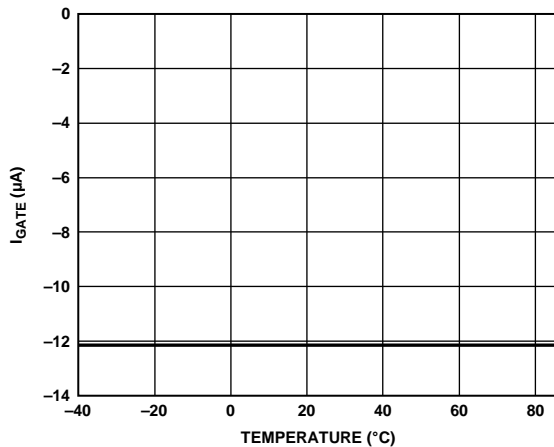

Figure 9. Gate Pull-Up Current vs. Temperature

05647-028

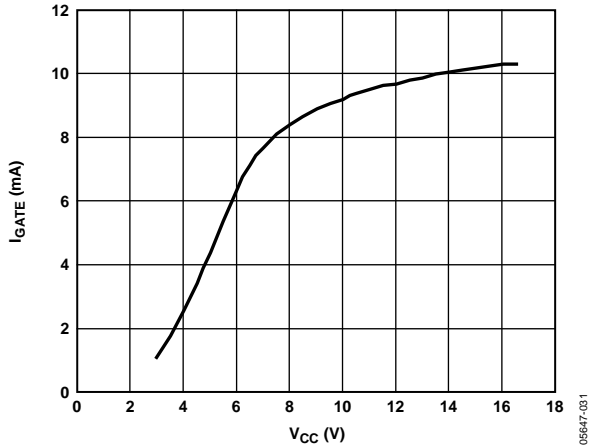

Figure 10. Gate Pull-Down Current vs. Supply Voltage at $V_{GATE} = 5\text{ V}$

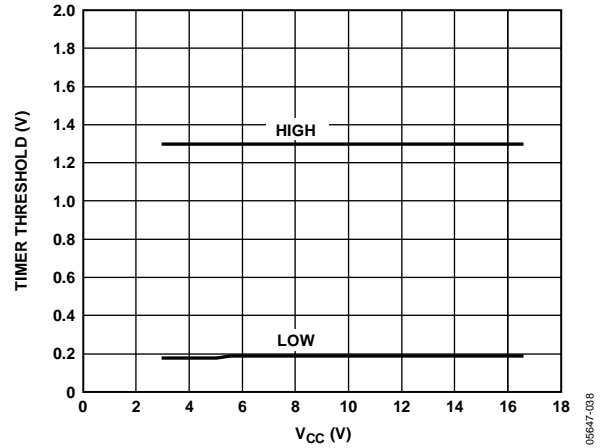

Figure 13. Timer Threshold vs. Supply Voltage

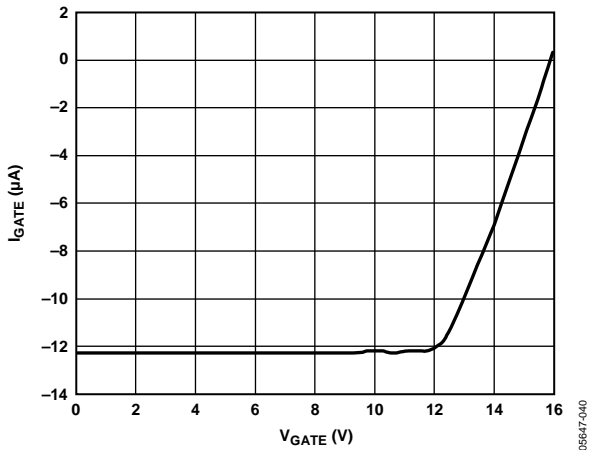

Figure 11. Gate Pull-Up Current vs. Gate Voltage at $V_{CC} = 5\text{ V}$

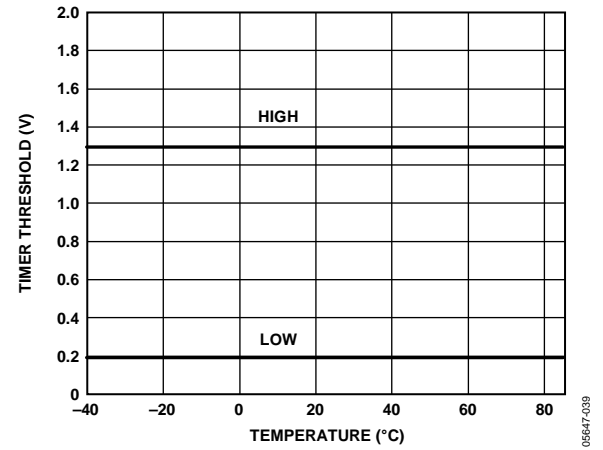

Figure 14. Timer Threshold vs. Temperature

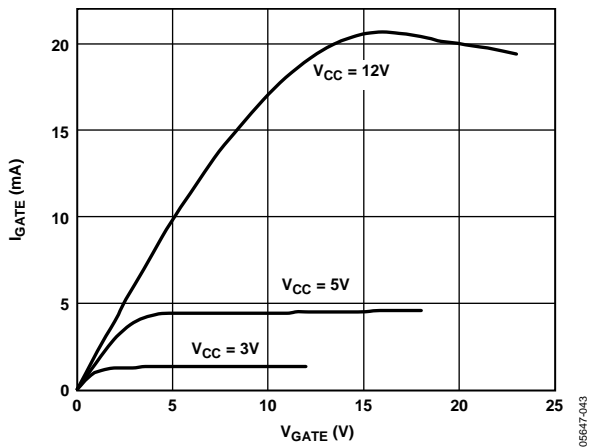

Figure 12. Gate Pull-Down Current vs. Gate Voltage

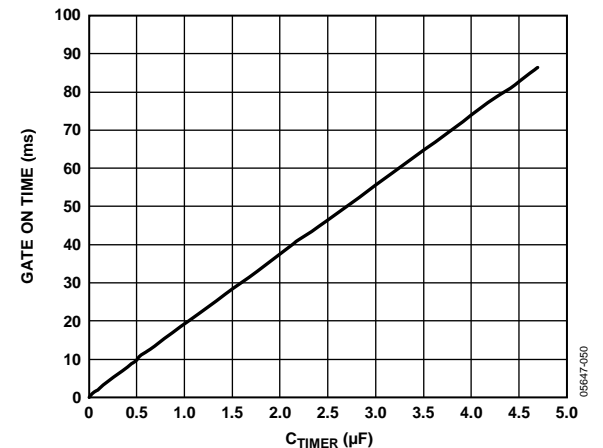

Figure 15. Gate On Time vs. Timer Capacitance During Current Limiting Condition

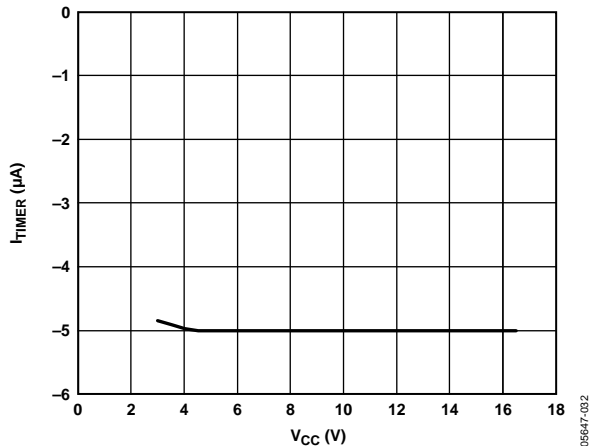

Figure 16. Timer Pull-Up Current (Initial Cycle) vs. Supply Voltage

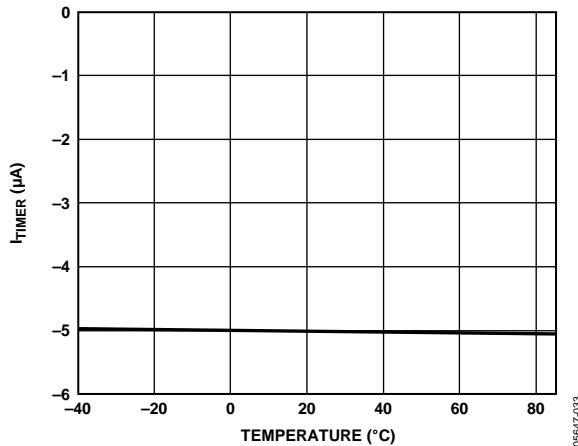

Figure 19. Timer Pull-Up Current (Initial Cycle) vs. Temperature

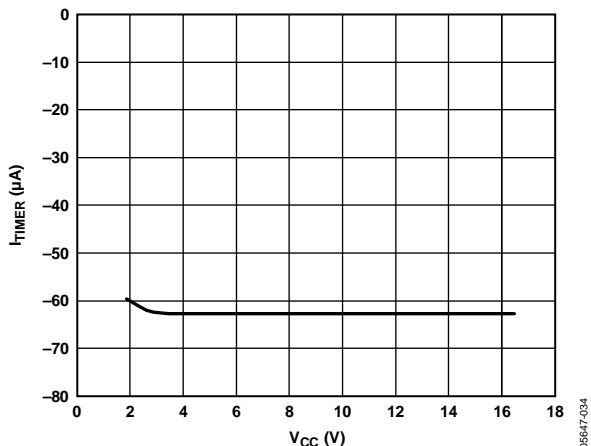

Figure 17. Timer Pull-Up Current (Circuit Breaker Delay) vs. Supply Voltage

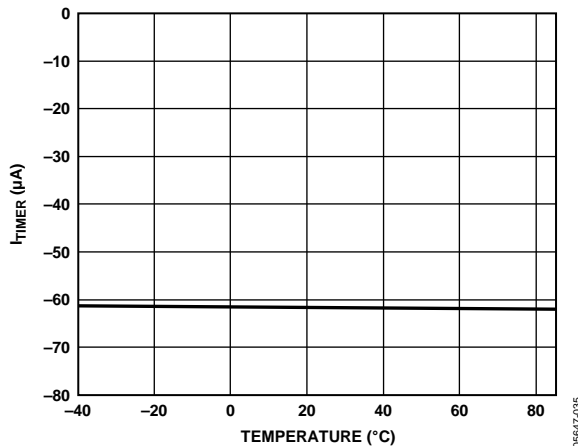

Figure 20. Timer Pull-Up Current (Circuit Breaker Delay) vs. Temperature

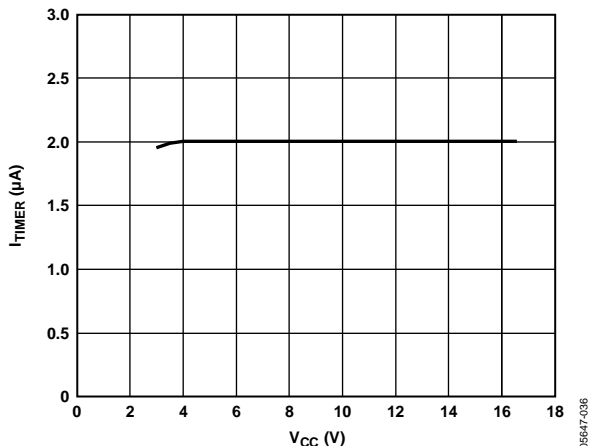

Figure 18. Timer Pull-Down Current (Cooldown/FET Off Cycle) vs. Supply Voltage

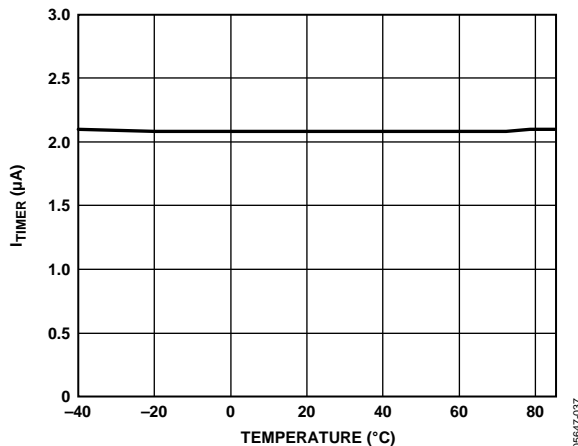

Figure 21. Timer Pull-Down Current (Cooldown/FET Off Cycle) vs. Temperature

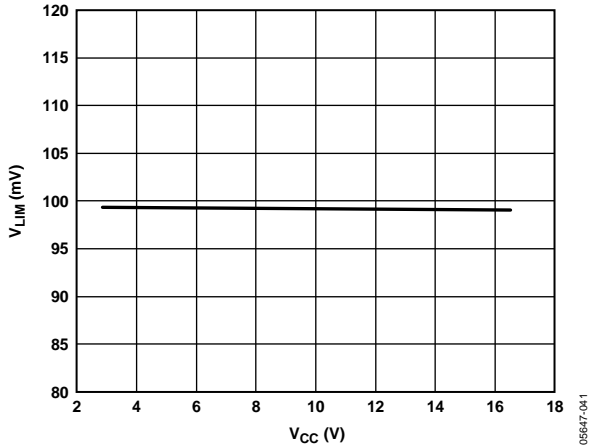

Figure 22. Circuit Breaker Limit Voltage vs. Supply Voltage

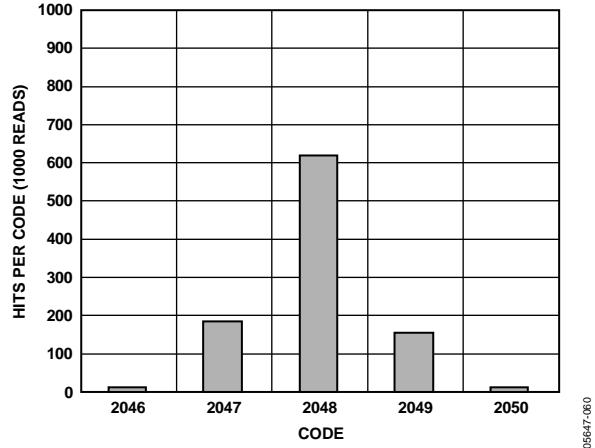

Figure 25. ADC Noise with Current Channel, Midcode Input, and 1000 Reads

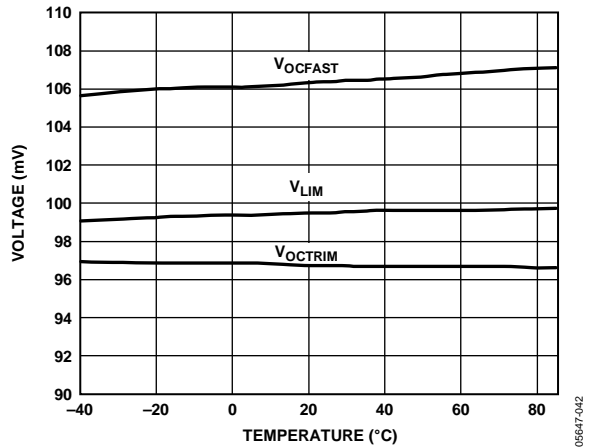

Figure 23. V_{OCTRIM}, V_{LIM}, V_{OCFAST} vs. Temperature

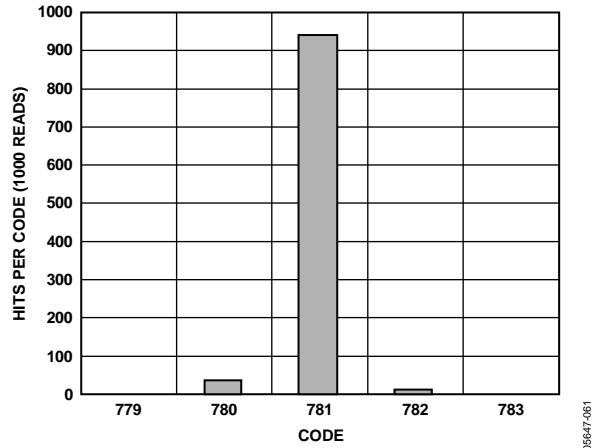

Figure 26. ADC Noise with 14:1 Voltage Channel, 5 V Input, and 1000 Reads

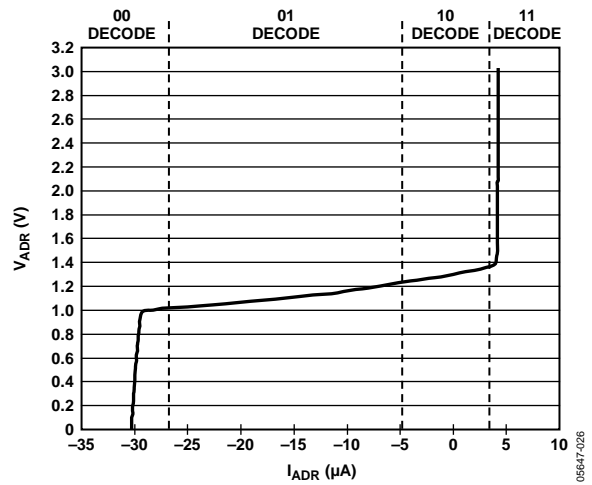

Figure 24. Address Pin Voltage vs. Address Pin Current for Four Addressing Options

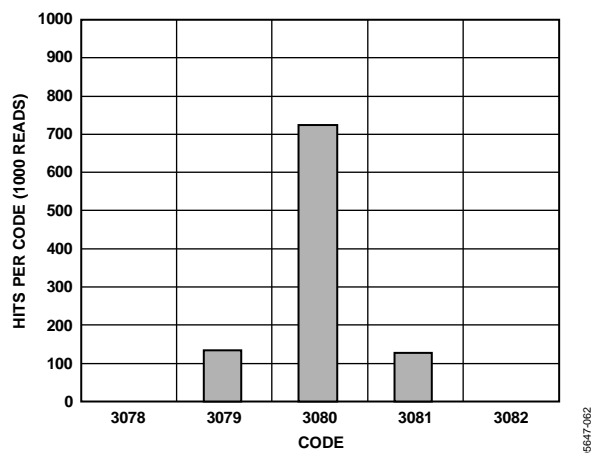

Figure 27. ADC Noise with 7:1 Voltage Channel, 5 V Input, and 1000 Reads

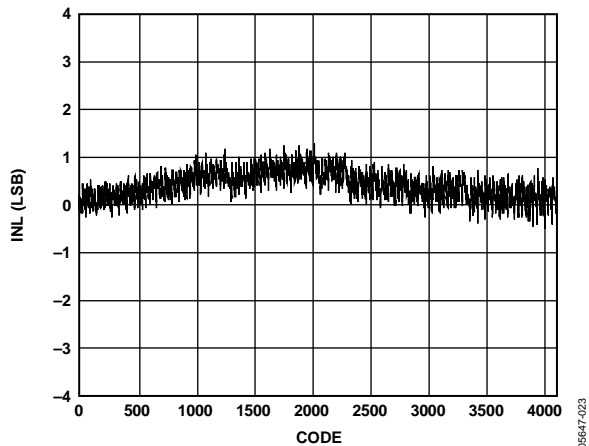

Figure 28. INL for ADC

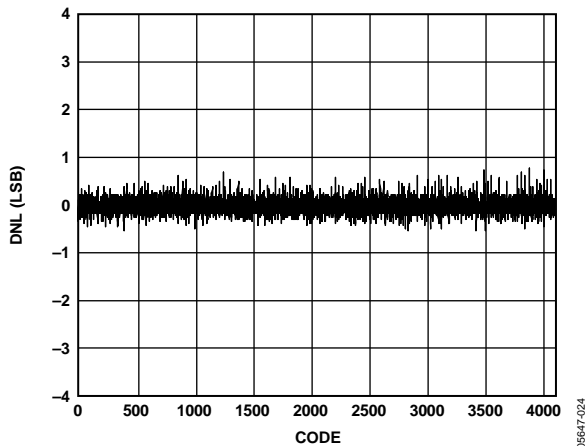

Figure 29. DNL for ADC

OVERVIEW OF THE HOT SWAP FUNCTION

When circuit boards are inserted into a live backplane, discharged supply bypass capacitors draw large transient currents from the backplane power bus as they charge. Such transient currents can cause permanent damage to connector pins, as well as dips on the backplane supply that can reset other boards in the system. The ADM1175 is designed to turn a circuit board supply voltage on and off in a controlled manner, allowing the circuit board to be safely inserted into or removed from a live backplane. The ADM1175 can reside either on the backplane or on the circuit board itself.

The ADM1175 controls the inrush current to a fixed maximum level by modulating the gate of an external N-channel FET placed between the live supply rail and the load. This hot swap function protects the card connectors and the FET itself from damage and limits any problems that can be caused by high current loads on the live supply rail.

The ADM1175 holds the GATE pin down (and therefore holds off the FET) until certain conditions are met. An undervoltage lockout circuit ensures that the device is provided with an adequate input supply voltage. After the input supply voltage is successfully detected, the device goes through an initial timing cycle to provide a delay before it attempts to hot swap. This delay ensures that the board is fully seated in the backplane before the board is powered up.

After the initial timing cycle is complete, the hot swap function is switched on under control of the ON/ONB pin. When ON/ONB is asserted (high for the ADM1175-1 and ADM1175-2, low for the ADM1175-3 and ADM1175-4), the hot swap operation starts.

The ADM1175 charges up the gate of the FET to turn on the load. It continues to charge up the GATE pin until the linear current limit (set to $100 \text{ mV}/R_{\text{SENSE}}$) is reached. For some combinations of low load capacitance and high current limit, this limit may not be reached before the load is fully charged up. If the current limit is reached, the ADM1175 regulates the GATE pin to keep the current at this limit. For currents above the overcurrent fault timing threshold, nominally $100 \text{ mV}/R_{\text{SENSE}}$, the current fault is timed by sourcing a current out to the TIMER pin. If the load becomes fully charged before the fault current limit time is reached (when the TIMER pin reaches 1.3 V), the current drops below the overcurrent fault timing threshold. The ADM1175 then charges the GATE pin higher to fully enhance the FET for lowest R_{ON} , and the TIMER pin is pulled down again.

If the fault current limit time is reached before the load drops below the current limit, a fault has been detected, and the hot swap operation is aborted by pulling down the GATE pin to turn off the FET.

The ADM1175-2 and ADM1175-4 are latched off. They attempt to hot swap again only when the ON/ONB pin is deasserted and then asserted again. The ADM1175-1 and ADM1175-3 retry the hot swap operation indefinitely, keeping the FET in its safe operating area (SOA) by using the TIMER pin to time a cool-down period between hot swap attempts. The current and voltage threshold combinations on the TIMER pin set the retry duty cycle to 3.8%.

The ADM1175 is designed to operate over a range of supplies from 3.15 V to 16.5 V.

UNDERVOLTAGE LOCKOUT

An internal undervoltage lockout (UVLO) circuit resets the ADM1175 if the voltage on the VCC pin is too low for normal operation. The UVLO has a low-to-high threshold of 2.8 V, with 80 mV hysteresis. Above 2.8 V supply voltage, the ADM1175 starts the initial timing cycle.

ON/ONB FUNCTION

The ADM1175-1 and ADM1175-2 have an active high ON pin. The ON pin is the input to a comparator that has a low-to-high threshold of 1.3 V, a 50 mV hysteresis, and a glitch filter of 3 μs . A low input on the ON pin turns off the hot swap operation by pulling the GATE pin to ground, turning off the external FET. The TIMER pin is also reset by turning on a pull-down current on this pin. A low-to-high transition on the ON pin starts the hot swap operation. A 10 k Ω pull-up resistor connecting the ON pin to the supply is recommended.

Alternatively, an external resistor divider at the ON pin can be used to program an undervoltage lockout value that is higher than the internal UVLO circuit, thereby setting the hot swap operation to start on specific voltage level on the VCC pin. An RC filter can be added at the ON pin to increase the delay time at card insertion if the initial timing cycle delay is insufficient.

The ADM1175-3 and ADM1175-4 have an active low ONB pin. This pin operates exactly as described above for the ON pin, but the polarity is reversed. This allows this pin to function as an overvoltage detector that can use the external FET as a circuit breaker for overvoltage conditions on the monitored supply.

TIMER FUNCTION

The TIMER pin handles several timing functions with an external capacitor, C_{TIMER} . There are two comparator thresholds: V_{TIMERH} (1.3 V) and V_{TIMERL} (0.2 V). The four timing current sources are a 5 μA pull-up, a 60 μA pull-up, a 2 μA pull-down, and a 100 μA pull-down. The 100 μA pull-down is a nonideal current source, approximating a 7 k Ω resistor below 0.4 V.

These current and voltage levels, together with the value of C_{TIMER} chosen by the user, determine the initial timing cycle time, the fault current limit time, and the hot swap retry duty cycle.

GATE AND TIMER FUNCTIONS DURING A HOT SWAP OPERATION

During hot insertion of a board onto a live supply rail at VCC, the abrupt application of supply voltage charges the external FET drain/gate capacitance, which can cause an unwanted gate voltage spike. An internal circuit holds GATE low before the internal circuitry wakes up. This substantially reduces the FET current surges at insertion. The GATE pin is also held low during the initial timing cycle until the ON pin is taken high to start the hot swap operation.

During a hot swap operation, the GATE pin is first pulled up by a 12.5 μA current source. If the current through the sense resistor reaches the overcurrent fault timing threshold (V_{OCTRIM}), a pull-up current of 60 μA on the TIMER pin is turned on and the GATE pin starts charging up. At a slightly higher voltage in the sense resistor, the error amplifier servos the GATE pin to maintain a constant current to the load by controlling the voltage across the sense resistor to the linear current limit, V_{LIM} .

A normal hot swap operation is complete when the board supply capacitors near full charge, and the current through the sense resistor drops to eventually reach the level of the board load current. As soon as the current drops below the overcurrent fault timing threshold, the current into the TIMER pin switches from 60 μA pull-up to 100 μA pull-down. The ADM1175 then drives the GATE voltage as high as it can to fully enhance the FET and reduce R_{ON} losses to a minimum.

A hot swap fails if the load current does not drop below the overcurrent fault timing threshold, V_{OCTRIM} , before the TIMER pin has charged up to 1.3 V. In this case, the GATE pin is then pulled down with a 1.5 mA to 7 mA current sink (this varies with supply voltage). The GATE pull-down stays on until a hot swap retry starts, which can be forced by deasserting and then reasserting the ON/ONB pin. On the ADM1175-1 and ADM1175-3, the device retries a hot swap operation automatically after a cooldown period.

The ADM1175 also features a method of protection from sudden load current surges, such as a low impedance fault, when the current seen across the sense resistor may go well beyond the linear current limit. If the fast overcurrent trip threshold, V_{OCFAST} , is exceeded, the 1.5 mA to 7 mA GATE pull-down is turned on immediately. This pulls the GATE voltage down quickly to enable the ADM1175 to limit the length of the current spike that passes through an external FET and to bring the current through the sense resistor back into linear regulation as quickly as possible. This process protects the backplane supply from sustained overcurrent conditions that can otherwise cause the backplane supply to droop during the overcurrent event.

CALCULATING CURRENT LIMITS AND FAULT CURRENT LIMIT TIME

The nominal linear current limit is determined by a sense resistor connected between the VCC pin and the SENSE pin, as given by Equation 1.

$$I_{\text{LIMIT(NOM)}} = V_{\text{LIM(NOM)}}/R_{\text{SENSE}} = 100 \text{ mV}/R_{\text{SENSE}} \quad (1)$$

The minimum linear fault current is given by Equation 2.

$$I_{\text{LIMIT(MIN)}} = V_{\text{LIM(MIN)}}/R_{\text{SENSE(MAX)}} = 97 \text{ mV}/R_{\text{SENSE(MAX)}} \quad (2)$$

The maximum linear fault current is given by Equation 3.

$$I_{\text{LIMIT(MAX)}} = V_{\text{LIM(MAX)}}/R_{\text{SENSE(MIN)}} = 103 \text{ mV}/R_{\text{SENSE(MIN)}} \quad (3)$$

The power rating of the sense resistor should be rated at the maximum linear fault current level.

The minimum overcurrent fault timing threshold current is given by Equation 4.

$$I_{\text{OCTRIM(MIN)}} = V_{\text{OCTRIM(MIN)}}/R_{\text{SENSE(MAX)}} = 90 \text{ mV}/R_{\text{SENSE(MAX)}} \quad (4)$$

The maximum fast overcurrent trip threshold current is given by Equation 5.

$$I_{\text{OCFAST(MAX)}} = V_{\text{OCFAST(MAX)}}/R_{\text{SENSE(MIN)}} = 115 \text{ mV}/R_{\text{SENSE(MIN)}} \quad (5)$$

The fault current limit time is the time that a device spends timing an overcurrent fault, and is given by Equation 6.

$$t_{\text{FAULT}} \approx 21.7 \times C_{\text{TIMER}} \text{ ms}/\mu\text{F} \quad (6)$$

INITIAL TIMING CYCLE

When VCC is first connected to the backplane supply, the internal supply (Time Point 1 in Figure 30) of the ADM1175 must be charged up. A very short time later (significantly less than 1 ms), the internal supply is fully up and, because the undervoltage lockout voltage is exceeded at VCC, the device comes out of reset. During this first short reset period, the GATE pin is held down with a 25 mA pull-down current, and the TIMER pin is pulled down with a 100 μA current sink.

The ADM1175 then goes through an initial timing cycle. At Time Point 2, the TIMER pin is pulled high with 5 μA . At Time Point 3, the TIMER reaches the V_{TIMERL} threshold, and the first portion of the initial cycle ends. The 100 μA current source then pulls down the TIMER pin until it reaches 0.2 V at Time Point 4. The initial cycle delay (Time Point 2 to Time Point 4) is related to C_{TIMER} as shown in Equation 7.

$$t_{\text{INITIAL}} \approx 270 \times C_{\text{TIMER}} \text{ ms}/\mu\text{F} \quad (7)$$

ADM1175

When the initial timing cycle terminates, the device is ready to start a hot swap operation (assuming that the ON/ONB pin is asserted). In the example shown in Figure 30, the ON pin is asserted at the same time that V_{CC} is applied; therefore, the hot swap operation starts immediately after Time Point 4. At this point, the FET gate is charged up with a 12.5 μA current source.

At Time Point 5, the threshold voltage of the FET is reached, and the load current begins to flow. The FET is controlled to keep the sense voltage at 100 mV (this corresponds to a maximum load current level defined by the value of R_{SENSE}).

At Time Point 6, V_{GATE} and V_{OUT} have reached their full potential, and the load current has settled to its nominal level. Figure 31 illustrates the situation where the ON pin is asserted after V_{CC} is applied.

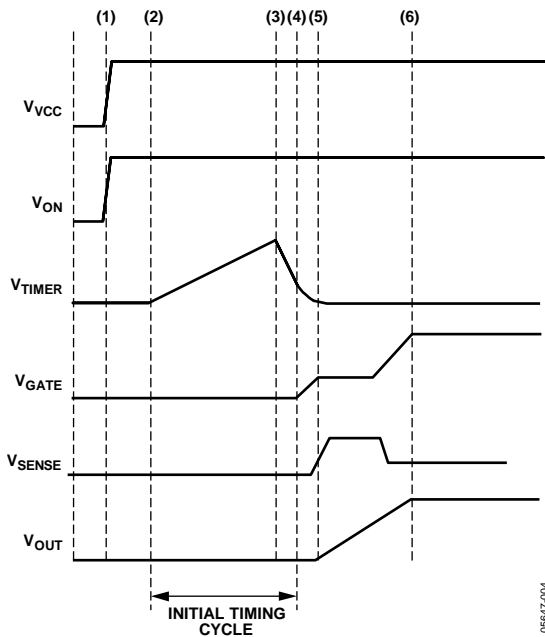

Figure 30. Startup (ON Asserts as Power Is Applied)

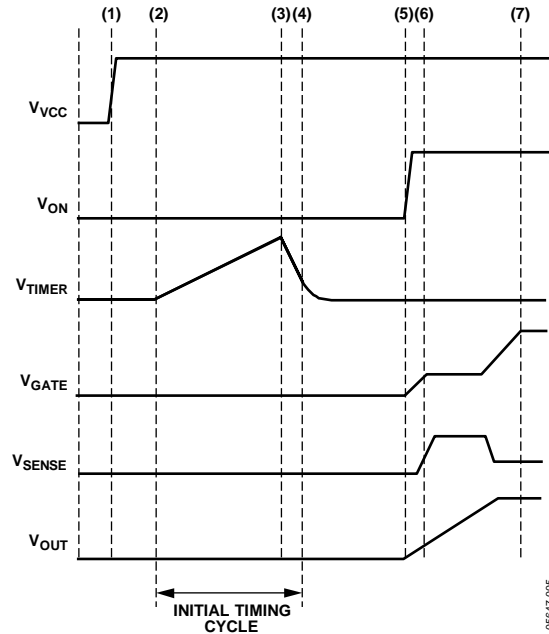

Figure 31. Startup (ON Asserts After Power Is Applied)

HOT SWAP RETRY CYCLE ON THE ADM1175-1 AND THE ADM1175-3

With the ADM1175-1 and the ADM1175-3, the device turns off the FET after an overcurrent fault and then uses the TIMER pin to time a delay before automatically retrying to hot swap.

As with all ADM1175 devices, an overcurrent fault is timed by charging the TIMER capacitor with a 60 μA pull-up current. When the TIMER pin reaches 1.3 V, the fault current limit time is reached, and the GATE pin is pulled down. On the ADM1175-1 and the ADM1175-3, the TIMER pin is then pulled down with a 2 μA current sink. When the TIMER pin reaches 0.2 V, it automatically restarts the hot swap operation.

The cooldown period is related to C_{TIMER} by Equation 8.

$$t_{COOL} \approx 550 \times C_{TIMER} \text{ ms}/\mu\text{F} \quad (8)$$

Therefore, the retry duty cycle is as given by Equation 9.

$$t_{FAULT}/(t_{COOL} + t_{FAULT}) \times 100\% = 3.8\% \quad (9)$$

VOLTAGE AND CURRENT READBACK

In addition to providing hot swap functionality, the ADM1175 also contains the components to allow voltage and current readback over an I²C bus. The voltage output of the current sense amplifier and the voltage on the VCC pin are fed into a 12-bit ADC via a multiplexer. The device can be instructed to convert voltage and/or current at any time during operation via an I²C command or an assertion on the convert start (CONV) pin. When all conversions are complete, the voltage and/or current values can be read back with 12-bit accuracy in two or three bytes.

SERIAL BUS INTERFACE

Control of the ADM1175 is carried out via the I²C bus. This interface is compatible with I²C fast mode (400 kHz maximum). The ADM1175 is connected to this bus as a slave device, under the control of a master device.

IDENTIFYING THE ADM1175 ON THE I²C BUS

The ADM1175 has a 7-bit serial bus slave address. When the device powers up, it does so with a default serial bus address. The five MSBs of the address are set to 11010; the two LSBs are determined by the state of the ADR pin. There are four different configurations available on the ADR pin that correspond to four different I²C addresses for the two LSBs (see Table 5). This scheme allows four ADM1175 devices to operate on a single I²C bus.

GENERAL I²C TIMING

Figure 32 and Figure 33 show timing diagrams for general write and read operations using the I²C. The I²C specification defines conditions for different types of read and write operations, which are discussed in the Write and Read Operations section. The general I²C protocol operates as follows:

1. The master initiates data transfer by establishing a start condition, defined as a high-to-low transition on the serial data line, SDA, while the serial clock line, SCL, remains high. This indicates that a data stream is to follow. All slave peripherals connected to the serial bus respond to the start condition and shift in the next eight bits, consisting of a 7-bit slave address (MSB first), plus an $\overline{R/W}$ bit that determines the direction of the data transfer, that is, whether data is written to or read from the slave device (0 = write, 1 = read).

The peripheral whose address corresponds to the transmitted address responds by pulling the data line low during the low period before the ninth clock pulse, known as the acknowledge bit, and holding it low during the high period of this clock pulse. All other devices on the bus remain idle, while the selected device waits for data to be read from it or written to it. If the $\overline{R/W}$ bit is 0, the master writes to the slave device. If the $\overline{R/W}$ bit is 1, the master reads from the slave device.

2. Data is sent over the serial bus in sequences of nine clock pulses: eight bits of data followed by an acknowledge bit from the slave device. Data transitions on the data line must occur during the low period of the clock signal and remain stable during the high period, because a low-to-high transition when the clock is high can be interpreted as a stop signal.

If the operation is a write operation, the first data byte after the slave address is a command byte. This tells the slave device what to expect next. It can be an instruction, such as telling the slave device to expect a block write; or it can be a register address that tells the slave where subsequent data is to be written.

Because data can flow in only one direction, as defined by the $\overline{R/W}$ bit, it is not possible to send a command to a slave device during a read operation. Before performing a read operation, it may be necessary to first execute a write operation to tell the slave what sort of read operation to expect and/or the address from which data is to be read.

3. When all data bytes are read or written, stop conditions are established. In write mode, the master pulls the data line high during the 10th clock pulse to assert a stop condition. In read mode, the master device releases the SDA line during the SCL low period before the ninth clock pulse, but the slave device does not pull it low. This is known as a no acknowledge. The master then takes the data line low during the SCL low period before the 10th clock pulse, then high during the 10th clock pulse to assert a stop condition.

Table 5. Setting I²C Addresses via the ADR Pin

Base Address	ADR Pin State	ADR Pin Logic State	Address in Binary ¹	Address in Hex
11010	Ground	00	1101000X	0xD0
	Resistor to ground	01	1101001X	0xD2
	Floating	10	1101010X	0xD4
	High	11	1101011X	0xD6

¹ X = don't care.

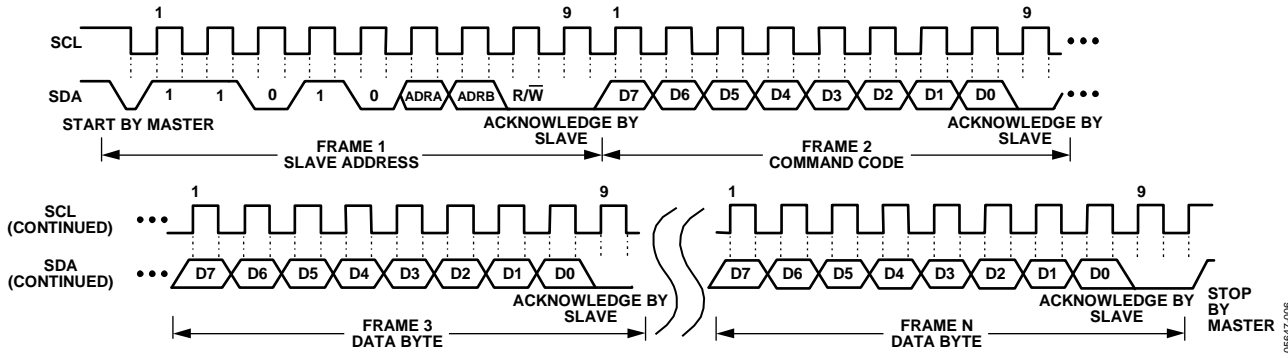

Figure 32. General I2C Write Timing Diagram

05647-006

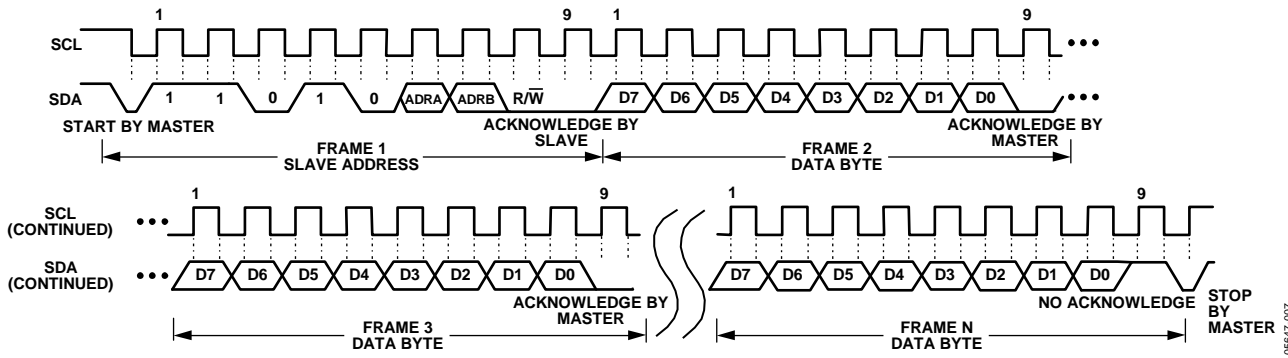

Figure 33. General I2C Read Timing Diagram

05647-007

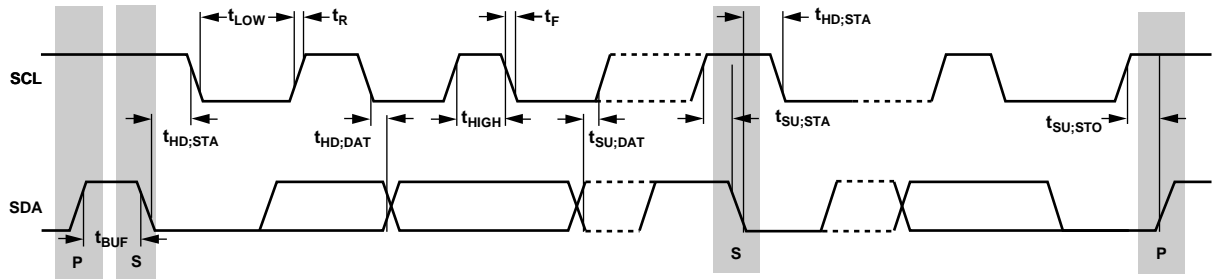

Figure 34. Serial Bus Timing Diagram

05647-008

WRITE AND READ OPERATIONS

The I²C specification defines several protocols for different types of read and write operations. The operations used in the ADM1175 are discussed in this section. Table 6 shows the abbreviations used in the command diagrams (see Figure 35 to Figure 40).

Table 6. I²C Abbreviations

Abbreviation	Condition
S	Start
P	Stop
R	Read
W	Write
A	Acknowledge
N	No acknowledge

QUICK COMMAND

The quick command operation allows the master to check if the slave is present on the bus, as follows:

1. The master device asserts a start condition on SDA.
2. The master sends the 7-bit slave address, followed by the write bit (low).
3. The addressed slave device asserts an acknowledge on SDA.
4. The master asserts a stop condition on SDA to end the transaction.

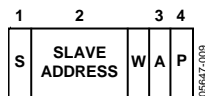

Figure 35. Quick Command

WRITE COMMAND BYTE

In the write command byte operation, the master device sends a command byte to the slave device, as follows:

1. The master device asserts a start condition on SDA.
2. The master sends the 7-bit slave address, followed by the write bit (low).
3. The addressed slave device asserts an acknowledge on SDA.
4. The master sends the command byte. The command byte is identified by an MSB = 0. An MSB = 1 indicates an extended register write (see the Write Extended Command Byte section).
5. The slave asserts an acknowledge on SDA.
6. The master asserts a stop condition on SDA to end the transaction.

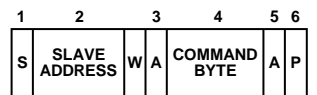

Figure 36. Write Command Byte

The seven LSBs of the command byte are used to configure and control the ADM1175. Table 7 provides details of the function of each bit.

Table 7. Command Byte Operations

Bit	Default	Name	Function
C0	0	V_CONT	LSB, set to convert voltage continuously. If readback is attempted before the first conversion is complete, the ADM1175 asserts an acknowledge and returns all 0s in the returned data.
C1	0	V_ONCE	Set to convert voltage once. Self-clears. I ² C asserts a no acknowledge on attempted reads until the ADC conversion is complete.
C2	0	I_CONT	Set to convert current continuously. If readback is attempted before the first conversion is complete, the ADM1175 asserts an acknowledge and returns all 0s in the returned data.
C3	0	I_ONCE	Set to convert current once. Self-clears. I ² C asserts a no acknowledge on attempted reads until the ADC conversion is complete.
C4	0	VRANGE	Selects different internal attenuation resistor networks for voltage readback. A 0 in C4 selects a 14:1 voltage divider. A 1 in C4 selects a 7:2 voltage divider. With an ADC full scale of 1.902 V, the voltage at the VCC pin for an ADC full-scale result is 26.35 V for VRANGE = 0 and 6.65 V for VRANGE = 1.
C5	0	N/A	Unused.
C6	0	STATUS_RD	Status read. When this bit is set, the data byte read back from the ADM1175 is the status byte. It contains the status of the device alerts. See Table 15 for full details of the status byte.

ADM1175

WRITE EXTENDED COMMAND BYTE

In the write extended command byte operation, the master device writes to one of the three extended registers of the slave device, as follows:

1. The master device asserts a start condition on SDA.
2. The master sends the 7-bit slave address, followed by the write bit (low).
3. The addressed slave device asserts an acknowledge on SDA.
4. The master sends the register address byte. The MSB of this byte is set to 1 to indicate an extended register write. The two LSBs indicate which of the three extended registers is to be written to (see Table 8). All other bits should be set to 0.
5. The slave asserts an acknowledge on SDA.
6. The master sends the extended command byte (see Table 9, Table 10, and Table 11).

7. The slave asserts an acknowledge on SDA.
8. The master asserts a stop condition on SDA to end the transaction.



Figure 37. Write Extended Byte

Table 9, Table 10, and Table 11 provide the details of each extended register.

Table 8. Extended Register Addresses

A6	A5	A4	A3	A2	A1	A0	Extended Register
0	0	0	0	0	0	1	ALERT_EN
0	0	0	0	0	1	0	ALERT_TH
0	0	0	0	0	1	1	CONTROL

Table 9. ALERT_EN Register Operations

Bit	Default	Name	Function
0	0	EN_ADC_OC1	LSB, enabled if a single ADC conversion on the I channel exceeds the threshold set in the ALERT_TH register.
1	0	EN_ADC_OC4	Enabled if four consecutive ADC conversions on the I channel exceed the threshold set in the ALERT_TH register.
2	1	EN_HS_ALERT	Enabled if the hot swap operation either latches off or enters a cooldown cycle because of an overcurrent event.
3	0	EN_OFF_ALERT	Enables an alert if the hot swap operation is turned off by a transition that deasserts the ON/ONB pin or by an operation that writes the SWOFF bit high.
4	0	CLEAR	Clears the OFF_ALERT, HS_ALERT, and ADC_ALERT status bits in the STATUS register. The value of these bits may immediately change if the source of the alert is not cleared and the alert function is not disabled. The CLEAR bit self-clears to 0 after the STATUS register bits are cleared.

Table 10. ALERT_TH Register Operations

Bit	Default	Function
[7:0]	FF	The ALERT_TH register sets the current level at which an alert occurs. Defaults to ADC full scale. The ALERT_TH 8-bit value corresponds to the top eight bits of the current channel data.

Table 11. CONTROL Register Operations

Bit	Default	Name	Function
0	0	SWOFF	LSB, forces the hot swap operation off. Equivalent to deasserting the ON/ONB pin.

READ VOLTAGE AND/OR CURRENT DATA BYTES

Depending on how the device is configured, the ADM1175 can be set up to provide information in three ways: voltage and current readback, voltage only readback, and current only readback. See the Write Command Byte section for more details.

Voltage and Current Readback

The ADM1175 digitizes both voltage and current. Three bytes are read back in the format shown in Table 12.

Table 12. Voltage and Current Readback Format

Byte	Contents	B7	B6	B5	B4	B3	B2	B1	B0
1	Voltage MSBs	V11	V10	V9	V8	V7	V6	V5	V4
2	Current MSBs	I11	I10	I9	I8	I7	I6	I5	I4
3	LSBs	V3	V2	V1	V0	I3	I2	I1	I0

Voltage Readback

The ADM1175 digitizes voltage only. Two bytes are read back in the format shown in Table 13.

Table 13. Voltage Only Readback Format

Byte	Contents	B7	B6	B5	B4	B3	B2	B1	B0
1	Voltage MSBs	V11	V10	V9	V8	V7	V6	V5	V4
2	Voltage LSBs	V3	V2	V1	V0	0	0	0	0

Current Readback

The ADM1175 digitizes current only. Two bytes are read back in the format shown in Table 14.

Table 14. Current Only Readback Format

Byte	Contents	B7	B6	B5	B4	B3	B2	B1	B0
1	Current MSBs	I11	I10	I9	I8	I7	I6	I5	I4
2	Current LSBs	I3	I2	I1	I0	0	0	0	0

The following series of events occurs when the master receives three bytes (voltage and current data) from the slave device:

1. The master device asserts a start condition on SDA.
2. The master sends the 7-bit slave address, followed by the read bit (high).
3. The addressed slave device asserts an acknowledge on SDA.
4. The master receives the first data byte.
5. The master asserts acknowledge on SDA.
6. The master receives the second data byte.
7. The master asserts an acknowledge on SDA.
8. The master receives the third data byte.
9. The master asserts a no acknowledge on SDA.
10. The master asserts a stop condition on SDA, and the transaction ends.

For cases where the master is reading voltage only or current only, only two data bytes are read and Step 7 and Step 8 are not required.

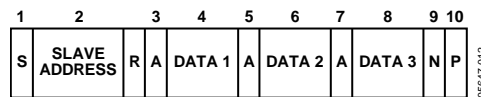

Figure 38. Three-Byte Read from ADM1175



Figure 39. Two-Byte Read from ADM1175

Converting ADC Codes to Voltage and Current Readings

Equation 10 and Equation 11 can be used to convert ADC codes representing voltage and current from the ADM1175 12-bit ADC into actual voltage and current values.

$$\text{Voltage} = (V_{\text{FULLSCALE}}/4096) \times \text{Code} \quad (10)$$

where:

$V_{\text{FULLSCALE}} = 6.65 \text{ V (7:2 range) or } 26.35 \text{ V (14:1 range)}$.

Code is the ADC voltage code read from the device (Bit V11 to V0).

$$\text{Current} = ((I_{\text{FULLSCALE}}/4096) \times \text{Code})/\text{Sense Resistor} \quad (11)$$

where:

$I_{\text{FULLSCALE}} = 105.84 \text{ mV}$.

Code is the ADC current code read from the device (Bit I11 to Bit I0).

Read Status Register

A single register of status data can also be read from the ADM1175 as follows:

1. The master device asserts a start condition on SDA.
2. The master sends the 7-bit slave address followed by the read bit (high).
3. The addressed slave device asserts an acknowledge on SDA.
4. The master receives the status byte.
5. The master asserts an acknowledge on SDA.

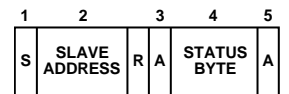

Figure 40. Status Read from ADM1175

Table 15 shows the ADM1175 STATUS registers in detail. Note that Bit 1, Bit 3, and Bit 5 are cleared by writing to Bit 4 (the CLEAR bit) of the ALERT_EN register.

ADM1175

Table 15. Status Byte Operations

Bit	Name	Function
0	ADC_OC	An ADC-based overcurrent comparison is detected on the last three conversions
1	ADC_ALERT	An ADC-based overcurrent trip has occurred, causing the alert. Cleared by writing to Bit 4 of the ALERT_EN register.
2	HS_OC	The hot swap operation is off due to an analog overcurrent event. On parts that latch off, this is the same as the HS_ALERT status bit (if EN_HS_ALERT = 1). On the retry parts, this indicates the current state: a 0 can indicate that the data was read during a period when the device was retrying, or that it has successfully hot swapped by retrying after at least one overcurrent timeout.
3	HS_ALERT	The hot swap operation has failed since the last time this was reset. Cleared by writing to Bit 4 of the ALERT_EN register.
4	OFF_STATUS	The state of the ON/ONB pin. Set to 1 if the input pin is deasserted. Can also be set to 1 by writing to the SWOFF bit of the CONTROL register.
5	OFF_ALERT	An alert has been caused by either the ON/ONB pin or the SWOFF bit. Cleared by writing to Bit 4 of the ALERT_EN register.

APPLICATIONS INFORMATION

APPLICATIONS WAVEFORMS

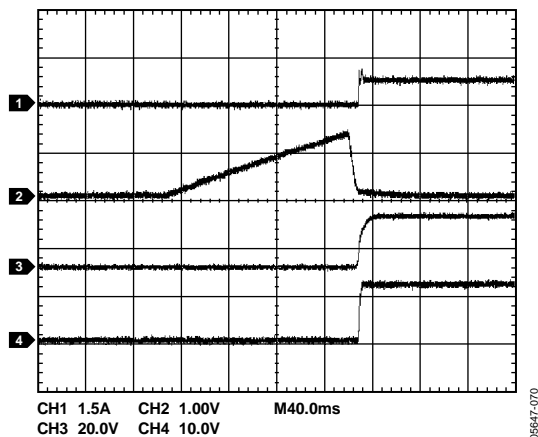

Figure 41. Inrush Current Control into 220 μ F Load
(Channel 1 = I_{LOAD} , Channel 2 = V_{TIMER} , Channel 3 = V_{GATE} , Channel 4 = V_{OUT})

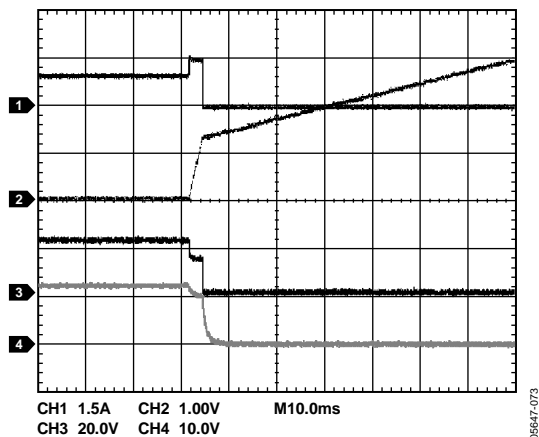

Figure 44. Overcurrent Condition During Operation (ADM1175-1 Model)
(Channel 1 = I_{LOAD} , Channel 2 = V_{TIMER} , Channel 3 = V_{GATE} , Channel 4 = V_{OUT})

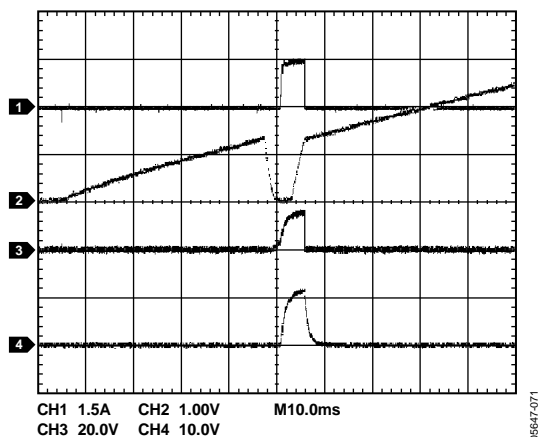

Figure 42. Overcurrent Condition at Startup (ADM1175-1 Model)
(Channel 1 = I_{LOAD} , Channel 2 = V_{TIMER} , Channel 3 = V_{GATE} , Channel 4 = V_{OUT})

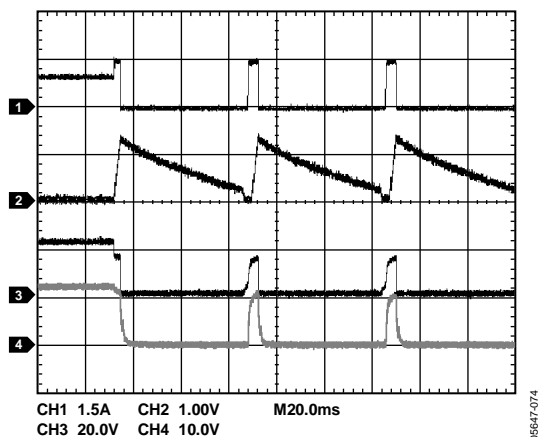

Figure 45. Overcurrent Condition During Operation (ADM1175-2 Model)
(Channel 1 = I_{LOAD} , Channel 2 = V_{TIMER} , Channel 3 = V_{GATE} , Channel 4 = V_{OUT})

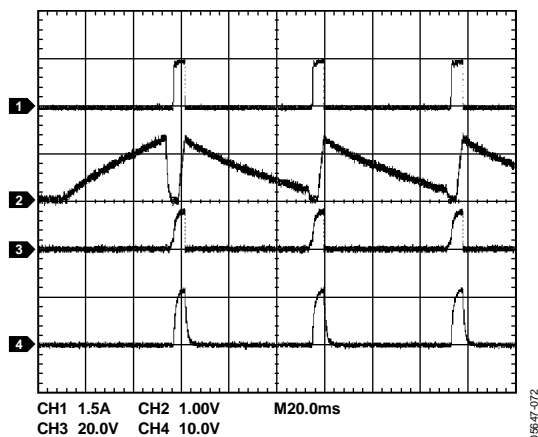

Figure 43. Overcurrent Condition at Startup (ADM1175-2 Model)
(Channel 1 = I_{LOAD} , Channel 2 = V_{TIMER} , Channel 3 = V_{GATE} , Channel 4 = V_{OUT})

KELVIN SENSE RESISTOR CONNECTION

When using a low value sense resistor for high current measurement, the problem of parasitic series resistance may arise. The lead resistance can be a substantial fraction of the rated resistance, making the total resistance a function of lead length. This problem can be avoided by using a Kelvin sense connection. This type of connection separates the current path through the resistor and the voltage drop across the resistor. Figure 46 shows the correct way to connect the sense resistor between the VCC pin and the SENSE pin of the ADM1175.

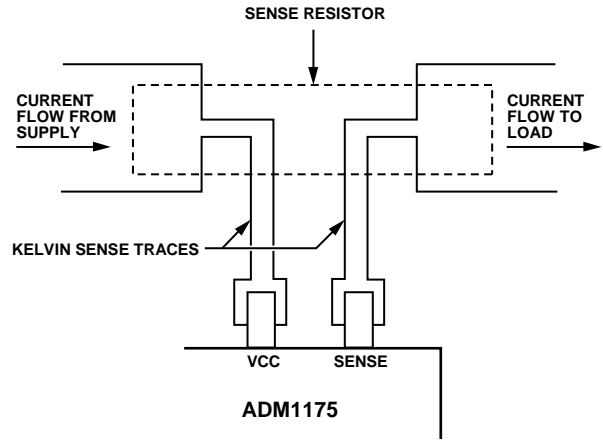
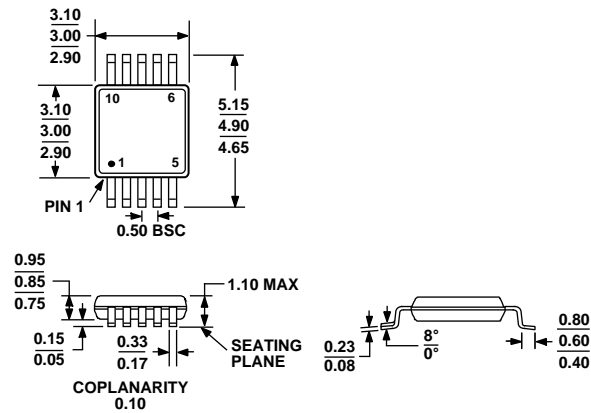

Figure 46. Kelvin Sense Connections

06647-015

OUTLINE DIMENSIONS



COMPLIANT TO JEDEC STANDARDS MO-187-BA

Figure 47. 10-Lead Mini Small Outline Package [MSOP] (RM-10)

Dimensions shown in millimeters

ORDERING GUIDE

Model	Hot Swap Retry Option	ON/ONB Pin	Temperature Range	Package Description	Package Option	Branding
ADM1175-1ARMZ-R7 ¹	Automatic Retry Version	ON	-40°C to +85°C	10-Lead MSOP	RM-10	M5P
ADM1175-2ARMZ-R7 ¹	Latched Off Version	ON	-40°C to +85°C	10-Lead MSOP	RM-10	M5R
ADM1175-3ARMZ-R7 ¹	Automatic Retry Version	ONB	-40°C to +85°C	10-Lead MSOP	RM-10	M5S
ADM1175-4ARMZ-R7 ¹	Latched Off Version	ONB	-40°C to +85°C	10-Lead MSOP	RM-10	M5T
EVAL-ADM1175EBZ ¹				Evaluation Board		

¹ Z = RoHS Compliant Part.

NOTES

Purchase of licensed I²C components of Analog Devices, Inc., or one of its sublicensed Associated Companies conveys a license for the purchaser under the Philips I²C Patent Rights to use these components in an I²C system, provided that the system conforms to the I²C Standard Specification as defined by Philips.